

**REGOLAZIONE MICRO SU ATTUATORI CORSA 100mm - ADJUSTMENT MICRO SWITCH ON ACTUATORS STROKE 100mm -
 REGULIERUNG MIKROSCHALTER AUF SPINDELMOTORE MIT HUB 100mm**











diamond 100, diamond 85, diamond 100s

S/N





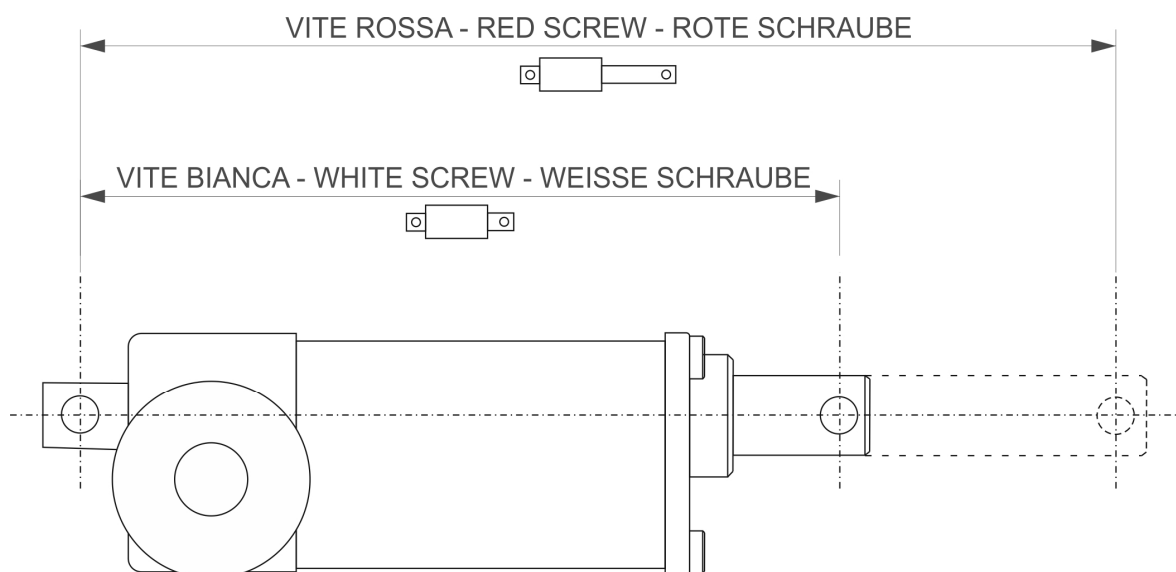

/

COD.

/

CODICE	DESCRIZIONE		
46330026	diamond 100 Martinetto AO-4/M 36V basamento Vite regolazione rossa	223 mm	307 mm 
46330045	diamond 100s Martinetto AO-4/M 36V basamento Vite regolazione bianca	230 mm 	310 mm
46330025	diamond 85 Martinetto AO-4/M 36V basamento Vite regolazione rossa	223 mm	302 mm 
46330055	diamond 85 spostamento laterale basamento Martinetto AO-1/M 36V Viti regolazione bianca e rossa	227 mm 	285 mm 
CODE	DESCRIPTION		
46330026	diamond 100 Actuator AO-4/M 36V brushes base Adjustment screw red	223 mm	307 mm 
46330045	diamond 100s Actuator AO-4/M 36V brushes base Adjustment screw white	230 mm 	310 mm
46330025	diamond 85 Actuator AO-4/M 36V brushes base Adjustment screw red	223 mm	302 mm 
46330055	diamond 85 side movement brushes base Actuator AO-1/M 36V Adjustment screws white and red	227 mm 	285 mm 



ART. NR.	BESCHREIBUNG		
46330026	diamond 100 Spindelmotor AO-4/M 36V Bürstengehäuse Regulierungsschraube rot	223 mm	307 mm 
46330045	diamond 100s Spindelmotor AO-4/M 36V Bürstengehäuse Regulierungsschraube weiss	230 mm 	310 mm
46330025	diamond 85 Spindelmotor AO-4/M 36V Bürstengehäuse Regulierungsschraube rot	223 mm	302 mm 
46330055	diamond 85 seitliche Verschiebbarkeit Bürstengehäuse Spindelmotor AO-1/M 36V Regulierungsschrauben weiss und rot	227 mm 	285 mm 